

INSTALLATION MANUAL

For the most current release of this manual,
please visit our website at cogan.com

V.2015.1

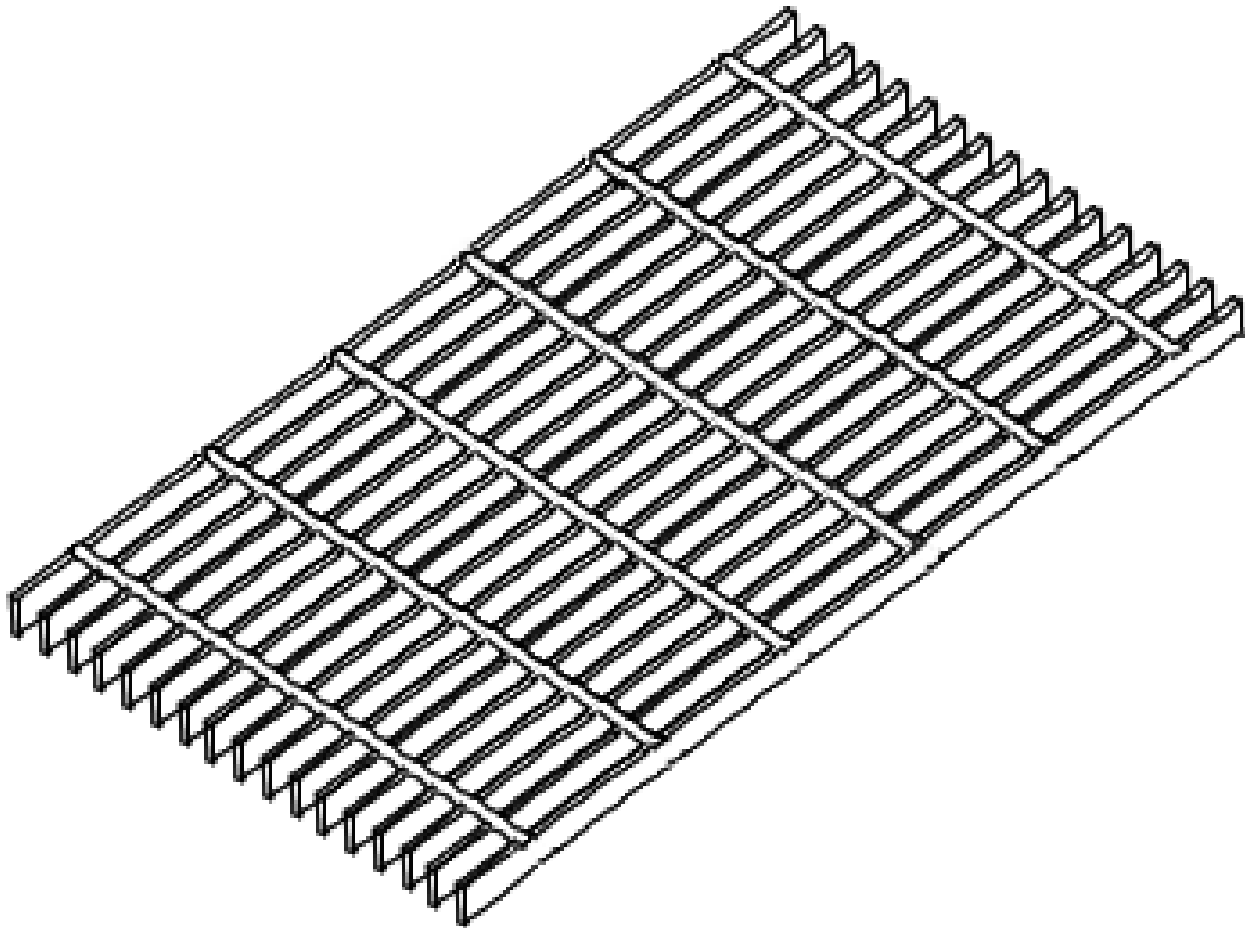

Product	Pre-Engineered Floor Decking System
Sub-product	Open Bar Grating

- Step by step installation of open bar grating.
- Refer to installation drawings for orientation of flooring



A Tradition of Quality Since 1901

cogan.com



Ø1/4"x1" HEX
HEAD TEK SCREW



Ø1/4"x1 3/4" HEX
HEAD TEK SCREW

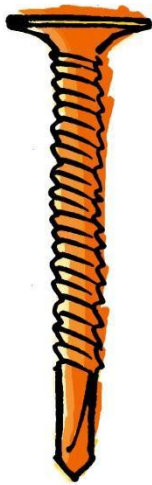

Ø1/4"x4" FLAT
HEAD TEK SCREW



Ø1/4"x2" FLAT
HEAD TEK SCREW

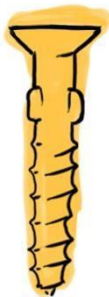

RESIN-DECK APPROVED
WOOD SCREW

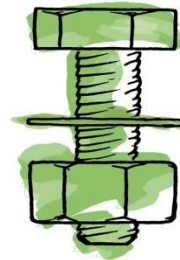

Ø5/16"x1" BOLT

FLOORING (BAR GRATING)



Install bar grating panels starting with row 1. The bar grating panel length is indicated on your installation drawing plan. Lay the panels side by side.

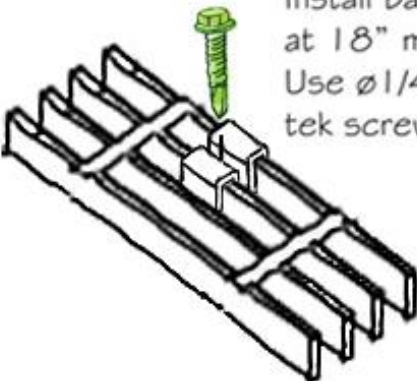

Install bar clips on all joists at 18" max. distance. Use $\phi 1/4" \times 1 3/4"$ hex head tek screw

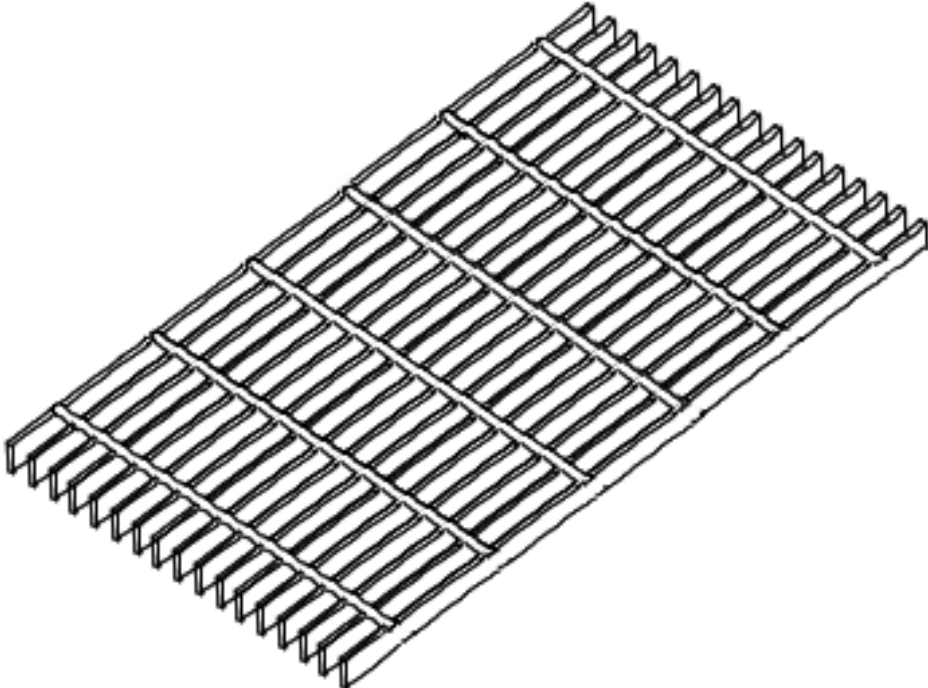
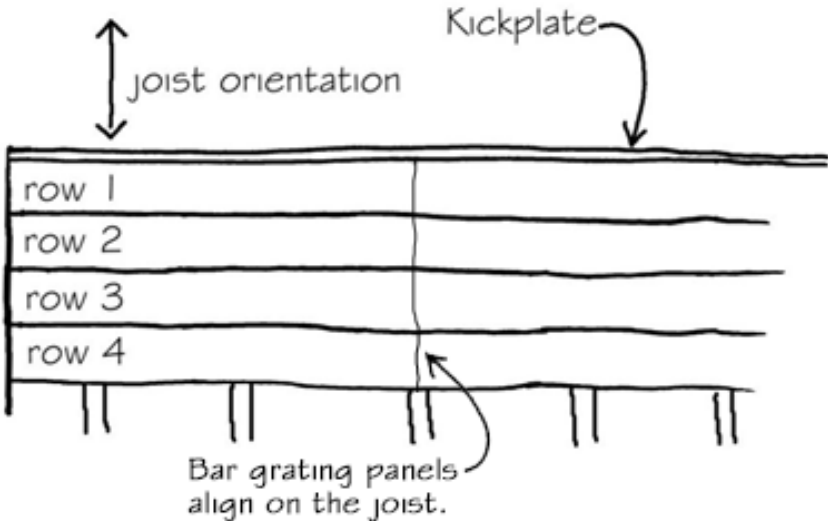

WALL BRACKET

